

|   |  |                               |
|---|--|-------------------------------|
|  | GLOBAL STANDARD  | Page 1 of 24                  |
|   | METAL-OXIDE POLYMER-HOUSED SURGE ARRESTERS WITHOUT GAPS FOR MV LINES | GSCC016<br>Rev. 02<br>12/2020 |

This document is intellectual property of ENEL Group distribution companies; reproduction or distribution of its contents in any way or by any means whatsoever is subject to the prior approval of the above mentioned companies which will safeguard their rights under the civil and penal codes.

## METAL-OXIDE POLYMER-HOUSED SURGE ARRESTERS FOR MV LINES

| Countries' I&N | Elaborated by                           |
|----------------|---|
| Argentina      | <b>Federico Luis Cetrangolo</b>         |
| Brazil         | <b>Romulo Alves Moreira Sales</b>       |
| Chile          | <b>Daniel Alejandro Gonzalez Sarkis</b> |
| Colombia       | <b>Juan Carlos Gómez Cubillos</b>       |
| Italy          | <b>Luca Giansante</b>                   |
| Peru           | <b>Roberto Sanchez Vargas</b>           |
| Romania        | <b>Vasilica Obrejan</b>                 |
| Spain          | <b>Juan Gonzalez Lara</b>               |

|                                     | Elaborated by                      | Verified by                        | Approved by              |
|-------------------------------------|------------------------------------|------------------------------------|--------------------------|
| <b>Global I&amp;N – O&amp;M/NCS</b> | <b>M Carmen Esteban Santamaria</b> | <b>Jean Pierre Goossens Alayon</b> | <b>Maurizio Mazzotti</b> |

| Revision | Data       | List of modifications  |
|----------|------------|--|
| 00       | 26/09/2018 | First emission   |
| 01       | 15/11/2018 | Editorial corrections and code table correction (Chile)  |
| 02       | 12/2020    | Reduction of equipment types. New definition for insulating support. Argentina, Romania and Brazil codes update. Editorial corrections |

|   |  |                               |
|---|--|-------------------------------|
|  | GLOBAL STANDARD  | Page 2 of 24                  |
|   | METAL-OXIDE POLYMER-HOUSED SURGE ARRESTERS WITHOUT GAPS FOR MV LINES | GSCC016<br>Rev. 02<br>12/2020 |

## INDEX

|             |  |          |
|-------------|--|----------|
| <b>1</b>    | <b>SCOPE .....</b>   | <b>6</b> |
| <b>2</b>    | <b>REFERENCE LAWS AND STANDARDS.....</b>                                   | <b>6</b> |
| <b>2.1</b>  | <b>Laws .....</b>  | <b>6</b> |
| <b>2.2</b>  | <b>Standards .....</b>   | <b>7</b> |
| <b>2.3</b>  | <b>Local standards.....</b>  | <b>8</b> |
| <b>3</b>    | <b>DEFINITIONS .....</b>   | <b>8</b> |
| <b>3.1</b>  | <b>Continuous operating voltage of an arrester (<math>U_c</math>).....</b> | <b>8</b> |
| <b>3.2</b>  | <b>Distribution class arrester.....</b>                                    | <b>8</b> |
| <b>3.3</b>  | <b>High current impulse of an arrester.....</b>                            | <b>8</b> |
| <b>3.4</b>  | <b>Lightning current impulse.....</b>                                      | <b>8</b> |
| <b>3.5</b>  | <b>Metal-oxide surge arrester without gaps.....</b>                        | <b>8</b> |
| <b>3.6</b>  | <b>Nominal discharge current of an arrester (<math>I_n</math>).....</b>    | <b>8</b> |
| <b>3.7</b>  | <b>Non-linear metal-oxide resistor (MO resistor).....</b>                  | <b>8</b> |
| <b>3.8</b>  | <b>Rated frequency of an arrester.....</b>                                 | <b>9</b> |
| <b>3.9</b>  | <b>Rated short-circuit current (<math>I_s</math>).....</b>                 | <b>9</b> |
| <b>3.10</b> | <b>Rated voltage of an arrester (<math>U_r</math>) .....</b>               | <b>9</b> |
| <b>3.11</b> | <b>Reference current of an arrester.....</b>                               | <b>9</b> |
| <b>3.12</b> | <b>Reference unified specific creepage distance, RUSCD .....</b>           | <b>9</b> |
| <b>3.13</b> | <b>Reference voltage of an arrester (<math>U_{ref}</math>).....</b>        | <b>9</b> |
| <b>3.14</b> | <b>Repetitive charge transfer rating (<math>Q_{rs}</math>).....</b>        | <b>9</b> |

|   |  |                               |
|---|--|-------------------------------|
|  | GLOBAL STANDARD  | Page 3 of 24                  |
|   | METAL-OXIDE POLYMER-HOUSED SURGE ARRESTERS WITHOUT GAPS FOR MV LINES | GSCC016<br>Rev. 02<br>12/2020 |

|       |  |    |
|-------|--|----|
| 3.15  | Residual voltage of an arrester (Ures).....            | 9  |
| 3.16  | Lightning impulse protective level (Upl or LIPL) ..... | 9  |
| 3.17  | Steep current impulse.....                             | 10 |
| 3.18  | Switching current impulse of an arrester .....         | 10 |
| 3.19  | Thermal charge transfer rating (Qth) .....             | 10 |
| 4     | <b>SERVICE CONDITIONS</b> .....                        | 10 |
| 4.1   | General service conditions .....                       | 10 |
| 4.2   | Specific service conditions .....                      | 10 |
| 4.2.1 | Pollution level .....                                  | 10 |
| 4.2.2 | Seismic qualification level.....                       | 11 |
| 4.2.3 | Altitude .....   | 11 |
| 5     | <b>TECHNICAL REQUIREMENTS</b> .....                    | 11 |
| 5.1   | Creepage distance .....                                | 11 |
| 6     | <b>DESIGNATION</b> .....                               | 11 |
| 6.1   | Designation Example .....                              | 12 |
| 7     | <b>CONSTRUCTION CHARACTERISTICS</b> .....              | 12 |
| 7.1   | Constitution .....                                     | 12 |
| 7.2   | Fixation .....   | 13 |
| 7.3   | Terminals to conductor and to disconnecter .....       | 14 |
| 7.4   | Disconnecter .....                                     | 14 |
| 7.5   | Protective treatments .....                            | 14 |
| 7.6   | Grounding .....  | 14 |

|   |   |                               |
|---|---|-------------------------------|
|  | GLOBAL STANDARD   | Page 4 of 24                  |
|   | METAL-OXIDE POLYMER-HOUSED SURGE<br>ARRESTERS WITHOUT GAPS FOR MV LINES | GSCC016<br>Rev. 02<br>12/2020 |

|             |   |           |
|-------------|---|-----------|
| <b>7.7</b>  | <b>Other characteristics .....</b>  | <b>14</b> |
| <b>8</b>    | <b>MARKING .....</b>  | <b>15</b> |
| <b>9</b>    | <b>TESTING .....</b>  | <b>15</b> |
| 9.1.1       | Type Tests (Design Tests).....  | 15        |
| 9.1.2       | Routine tests.....  | 17        |
| 9.1.3       | Acceptance tests.....   | 17        |
| 9.1.4       | Sample plan .....   | 17        |
| <b>10</b>   | <b>TECHNICAL CONFORMITY ASSESSMENT .....</b>  | <b>18</b> |
| <b>10.1</b> | <b>Local Certifications.....</b>  | <b>18</b> |
| <b>11</b>   | <b>GUARANTEE.....</b>   | <b>18</b> |
| <b>12</b>   | <b>CONDITIONS OF SUPPLY .....</b>   | <b>18</b> |
| <b>13</b>   | <b>ANNEX A TECHNICAL REQUIREMENTS .....</b>   | <b>19</b> |
| <b>14</b>   | <b>ANNEX B- LOCAL SECTIONS.....</b>   | <b>20</b> |
| <b>14.1</b> | <b>E-DISTRIBUZIONE-ITALIA, E-DISTRIBUȚIE BANAT, E-DISTRIBUȚIE DOBROGEA, E-DISTRIBUȚIE MUNTENIA...20</b> |           |
| 14.1.1      | Replaced Local standards: .....   | 20        |
| <b>14.2</b> | <b>Supply.....</b>  | <b>20</b> |
| <b>14.3</b> | <b>ENDESA DISTRIBUCIÓN ELÉCTRICA- SPAIN .....</b>   | <b>20</b> |
| 14.3.1      | Replaced Local standards: .....   | 20        |
| <b>14.4</b> | <b>ENEL DISTRIBUCION COLOMBIA.....</b>  | <b>20</b> |
| 14.4.1      | Replaced Local standards: .....   | 20        |
| 14.4.2      | Reference local law and standards: .....  | 20        |
| <b>14.5</b> | <b>ENEL DISTRIBUCION PERÚ.....</b>  | <b>20</b> |
| 14.5.1      | Replaced Local standards: .....   | 20        |

|   |   |                               |
|---|---|-------------------------------|
|  | GLOBAL STANDARD   | Page 5 of 24                  |
|   | METAL-OXIDE POLYMER-HOUSED SURGE<br>ARRESTERS WITHOUT GAPS FOR MV LINES | GSCC016<br>Rev. 02<br>12/2020 |

|             |   |           |
|-------------|---|-----------|
| <b>14.6</b> | <b>ENEL DISTRIBUCION CHILE .....</b>  | <b>20</b> |
| 14.6.1      | Replaced Local standards: .....   | 20        |
| 14.6.2      | Reference local law and standards: .....  | 20        |
| <b>14.7</b> | <b>ENEL DISTRIBUCAO RIO, ENEL DISTRIBUCAO CEARÁ, ENEL DISTRIBUCAO GOIAS, ENEL SAO PAULO .....</b> | <b>21</b> |
| 14.7.1      | Replaced Local standards: .....   | 21        |
| <b>15</b>   | <b>ANNEX C - TECHNICAL CHECK LIST .....</b>   | <b>22</b> |
| <b>16</b>   | <b>ANNEX D - STANDARDIZED DESIGNATION TO CREATE NEW CODES.....</b>                                | <b>23</b> |
| <b>17</b>   | <b>ANNEX E, APPLICABILITY TEST TABLE .....</b>  | <b>24</b> |

|   |  |                               |
|---|--|-------------------------------|
|  | GLOBAL STANDARD  | Page 6 of 24                  |
|   | METAL-OXIDE POLYMER-HOUSED SURGE ARRESTERS WITHOUT GAPS FOR MV LINES | GSCC016<br>Rev. 02<br>12/2020 |

## 1 SCOPE

The aim of this document is to provide technical requirements for the supply of MV surge arresters to be used in the MV lines of the distribution networks of Enel Group Distribution Companies, listed below:

- Enel Codensa Colombia
- Enel Distribución Peru Perú
- Edesur Argentina
- E-distributie Banat Romania
- E-distributie Dobrogea Romania
- E-distributie Muntenia Romania
- E-distribuzione Italy
- E-Distribución Redes Digitales Spain
- Enel Distribución Chile Chile
- Enel Distribuição Ceará Brazil
- Enel Distribuição Rio Brazil
- Enel Distribuição Goiás Brazil
- Enel Distribuição São Paulo Brazil

This document specifies the characteristics and tests that shall be accomplished by the surge arresters used in the medium voltage distribution network, which shall be according to the IEC 60099-4.

Additional prescriptions or integration of the main common part are reported in Local Sections with the same corresponding clause or sub-clause number.

The local standards replaced by this standard appear in the local section.

## 2 REFERENCE LAWS AND STANDARDS

The list of reference laws and standards are mentioned below in this document.

### 2.1 Laws

Brazil

- NR-10 - Segurança em Instalações e Serviços em Eletricidade

Chile

- REGLAMENTO DE SEGURIDAD DE LAS INSTALACIONES ELÉCTRICAS DESTINADAS A LA PRODUCCIÓN, TRANSPORTE, PRESTACIÓN DE SERVICIOS COMPLEMENTARIOS, SISTEMAS DE ALMACENAMIENTO Y DISTRIBUCIÓN DE ENERGÍA ELÉCTRICA y todos sus Pliegos Técnicos.

Colombia

|   |  |                               |
|---|--|-------------------------------|
|  | GLOBAL STANDARD  | Page 7 of 24                  |
|   | METAL-OXIDE POLYMER-HOUSED SURGE ARRESTERS WITHOUT GAPS FOR MV LINES | GSCC016<br>Rev. 02<br>12/2020 |

- RETIE, Reglamento Técnico de Instalaciones Eléctricas.

Peru

- Código Nacional de Electricidad – Suministro 2011.

Romania

- NTE 001/03/00 – Normativ privind alegerea izolației, coordonarea izolației și protecția instalațiilor electroenergetice împotriva supratensiunilor
- NTE 003/04/00 – Normativ pentru construcția liniilor electrice aeriene de energie electrică cu tensiuni peste 1000 V

Spain

- R.D. 614/2001, de 8 de junio, sobre disposiciones mínimas para la protección de la salud y seguridad de los trabajadores frente al riesgo eléctrico.
- R.D. 337/2014, de 9 de mayo, por el que se aprueban el Reglamento sobre condiciones técnicas y garantías de seguridad en instalaciones eléctricas de alta tensión y sus Instrucciones Técnicas Complementarias ITC-RAT 01 a 23.
- R.D. 223/2008, de 15 de febrero, por el que se aprueban el Reglamento sobre condiciones técnicas y garantías de seguridad en líneas eléctricas de alta tensión y sus instrucciones técnicas complementarias ITC-LAT 01 a 09.

## 2.2 Standards

The following standards are needful for the application of this Global Standard.

- IEC 60050. International Electrotechnical Vocabulary
- IEC 60099-4: Metal-oxide surge arresters without gaps for a.c. systems
- IEC 60695-11-10 Fire hazard testing - Part 11-10: Test flames - 50 W horizontal and vertical flame test methods.
- ISO 1461. Hot dip galvanized coatings on fabricated iron and steel articles -- Specifications and test methods.
- IEC TS 60815-1: Selection and dimensioning of high-voltage insulators intended for use in polluted conditions - Part 1: Definitions, information and general principles
- IEC TS 60815-3: Selection and dimensioning of high-voltage insulators intended for use in polluted conditions - Part 3: Polymer insulators for a.c. systems.
- IEC 60587: Electrical insulating materials used under severe ambient conditions - Test methods for evaluating resistance to tracking and erosion
- IEC TR 62271-300: High-voltage switchgear and controlgear - Part 300: Seismic qualification of alternating current circuit-breakers
- ISO 3676:2012: Packaging -- Complete, filled transport packages and unit loads -- Unit load dimensions

|   |  |                               |
|---|--|-------------------------------|
|  | GLOBAL STANDARD  | Page 8 of 24                  |
|   | METAL-OXIDE POLYMER-HOUSED SURGE ARRESTERS WITHOUT GAPS FOR MV LINES | GSCC016<br>Rev. 02<br>12/2020 |

### 2.3 Local standards

See local section

## 3 DEFINITIONS

### 3.1 Continuous operating voltage of an arrester ( $U_c$ )

Designated permissible R.M.S. value of power-frequency voltage that may be applied continuously between the arrester terminals in accordance with IEC 60099-4.

### 3.2 Distribution class arrester

Arrester intended to be used on distribution systems, typically of  $U_s \leq 52$  kV, in order to protect components primarily from the effects of lightning.

### 3.3 High current impulse of an arrester

Peak value discharge current having a 4/10 impulse shape which is used to test the stability of the arrester on direct lightning strokes.

### 3.4 Lightning current impulse

8/20 current impulse with limits on the adjustment of equipment such that the measured values are from  $7 \mu s$  to  $9 \mu s$  for the virtual front time and from  $18 \mu s$  to  $22 \mu s$  for the time to half-value on the tail.

### 3.5 Metal-oxide surge arrester without gaps

Arrester having non-linear MO resistors connected in series and/or in parallel without any integrated series or parallel spark gaps, incorporated in a housing with terminals for electrical and mechanical connection.

### 3.6 Nominal discharge current of an arrester ( $I_n$ )

Peak value of lightning current impulse which is used to classify an arrester in accordance with IEC 60099-4.

### 3.7 Non-linear metal-oxide resistor (MO resistor)

Part of the surge arrester which, by its non-linear voltage versus current characteristics, acts as a low resistance to overvoltages, thus limiting the voltage across the arrester terminals and as a high resistance at normal power-frequency voltage.



|   |  |                               |
|---|--|-------------------------------|
|  | GLOBAL STANDARD  | Page 9 of 24                  |
|   | METAL-OXIDE POLYMER-HOUSED SURGE ARRESTERS WITHOUT GAPS FOR MV LINES | GSCC016<br>Rev. 02<br>12/2020 |

### 3.8 Rated frequency of an arrester

Frequency of the power system on which the arrester is designed to be used.

### 3.9 Rated short-circuit current (Is)

Highest tested power-frequency current that may develop in a failed arrester as a short-circuit current without causing violent shattering of the housing or any open flames for more than two minutes under the specified test conditions.

### 3.10 Rated voltage of an arrester (Ur)

Maximum permissible 10 s power-frequency R.M.S.. overvoltage that can be applied between the arrester, as verified in the TOV test and the operating duty test.

### 3.11 Reference current of an arrester

Peak value (the higher peak value of the two polarities if the current is asymmetrical) of the resistive component of a power-frequency current used to determine the reference voltage of the arrester.

### 3.12 Reference unified specific creepage distance, RUSCD

Initial value of unified specific creepage distance for a pollution site before correction for size, profile, mounting position, etc. according to this technical specification and generally expressed in mm/kV (see IEC/TS 60815-3). RUSCD values are related to the higher voltage between phase and ground.

### 3.13 Reference voltage of an arrester (Uref)

Peak value of power-frequency voltage divided by  $\sqrt{2}$ , which is obtained when the reference current flows through the arrester.

### 3.14 Repetitive charge transfer rating (Qrs)

Maximum specified charge transfer capability of an arrester, in the form of a single event or group of surges that may be transferred through an arrester without causing mechanical failure or unacceptable electrical degradation to the MO resistors.

### 3.15 Residual voltage of an arrester (Ures)

Peak value of voltage that appears between the terminals of an arrester during the passage of discharge current.

### 3.16 Lightning impulse protective level (Upl or LIPL)

Maximum peak voltage on the terminals of a surge arrester subjected to lightning impulses under specific conditions

### 3.17 Steep current impulse

Current impulse with a virtual front time of 1  $\mu$ s with limits in the adjustment of equipment such that the measured values are from 0,9  $\mu$ s to 1,1  $\mu$ s and the virtual time to half-value on the tail is no longer than 20  $\mu$ s.

### 3.18 Switching current impulse of an arrester

Peak value of discharge current a virtual front time greater than 30  $\mu$ s but less than 100  $\mu$ s and a virtual time to half-value on the tail of roughly twice the virtual front time.

### 3.19 Thermal charge transfer rating (Qth)

Maximum specified charge that may be transferred through an arrester or arrester section within 3 minutes in a thermal recovery test without causing a thermal runaway.

## 4 SERVICE CONDITIONS

### 4.1 General service conditions

The reference service conditions are the normal service conditions of IEC 60099-4, see point 5.4.1.

### 4.2 Specific service conditions

#### 4.2.1 Pollution level

Creepage distance has been determined according to the level of pollution determined for each global code and IEC/TS 60815 series (see part IEC/TS 60815-3)

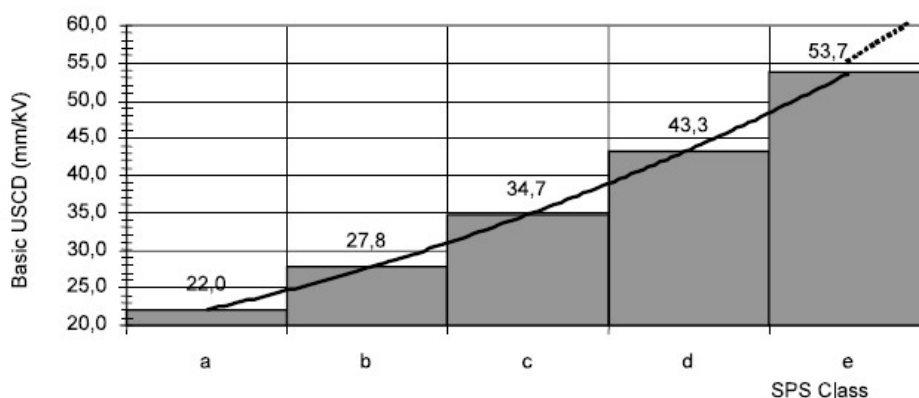



Table 1 Relation between SPS Class and RUSCD for Polymer Insulators

Note: RUSCD values are related to the higher voltage between phase and ground.

|   |  |  |                               |
|---|--|--|-------------------------------|
|  | GLOBAL STANDARD  |  | Page 11 of 24                 |
|   | METAL-OXIDE POLYMER-HOUSED SURGE ARRESTERS WITHOUT GAPS FOR MV LINES |  | GSCC016<br>Rev. 02<br>12/2020 |

#### 4.2.2 Seismic qualification level

The following considerations regarding the seismic qualification level shall be taken into account:

|          | AR | BR | CO               |  | CH        | ES | IT               | PE               | RO               |
|----------|----|----|------------------|--|-----------|----|------------------|------------------|------------------|
| Standard | NA | NA | IEC/TR 62271-300 | Reglamento Colombiano de Construcción Sismo resistente | ETGI-1020 | NA | IEC/TR 62271-300 | IEC/TR 62271-300 | IEC/TR 62271-300 |
| Level    | NA | NA | AF3              |  |           | NA | AF5              | AF5              | AF5              |

Table 2 – Seismic Qualification Level

#### 4.2.3 Altitude

The reference altitude in Colombia is 2.700 masl.

### 5 TECHNICAL REQUIREMENTS

This type of surge-arresters shall protect the equipment from overvoltage, mainly the ones produced by the effects of lightning.

According to the IEC 60099-4 classification, surge arresters for MV lines shall be Distribution High class, this is:

| Arrester class Distribution High (DH)        |              |
|--|--------------|
| $I_n$ (Nominal discharge current)            | 10 kA        |
| $Q_{rs}$ (Repetitive charge transfer rating) | $\geq 0,4 C$ |
| $Q_{th}$ (Thermal charge transfer rating)    | $\geq 1,1 C$ |

Table 3 Surge Arrester Classification

See the table in Annex A for the technical requirements.

#### 5.1 Creepage distance

Creepage distance shall be, as a minimum, in compliance with IEC 60815-1 and IEC 60815-3. In Annex A, Technical Requirements, it will be determined the creepage distance for each code.

### 6 DESIGNATION

Surge arresters for the distribution grid shall be designated by letters SA MOV (surge arrester metal oxide varistor) followed by DH (high class according IEC 60099-4), the Rated voltage, UR, in kV, a dash and the Continuous operating voltage, UC, in kV.

|   |  |                               |
|---|--|-------------------------------|
|  | GLOBAL STANDARD  | Page 12 of 24                 |
|   | METAL-OXIDE POLYMER-HOUSED SURGE ARRESTERS WITHOUT GAPS FOR MV LINES | GSCC016<br>Rev. 02<br>12/2020 |

## 6.1 Designation Example

Designation for code 170012: SA MOV DH UR-18/UC-15,3, surge arrester metal oxide varistor type Distribution Class (nominal discharge current, 10 kA), Rated voltage, 18 kV and Continuous operating voltage 15,3 kV.

## 7 CONSTRUCTION CHARACTERISTICS

### 7.1 Constitution

This type of surge arresters shall be constituted by non-linear metal oxide- zinc oxide- resistors incorporated in a housing with terminals for electrical and mechanical connection and without spark gaps.

The arresters shall have a polymeric hydrophobic housing able to withstand voltage during conduction of lightning and switching impulse currents and during anticipated maximum power frequency overvoltages. Its design shall accomplish the criteria of IEC 60815 series. The housing shall be prepared for external use and it shall be manufactured in silicone-rubber free of EPDM or rubbers with natural origin.

Multi column surge arresters and arresters with enclosed gas and a separate sealing system are not allowed.

#### 7.1.1.1.1 Silicone rubber

Silicone-rubber shall be **HTV solid silicone type (High Temperature Vulcanized – solid silicone rubber)**.

This type of silicone rubber is solid and vulcanizes at a high temperature (near 200°C).

The characteristics of the silicone rubber are described in the table below:

| Mechanical characteristics | Standard   | Minimum value HTV | Unit of Measurement |
|----------------------------|------------|-------------------|---------------------|
| Density                    | ISO 1183-1 | 1,5               | g/cm <sup>3</sup>   |
| Hardness                   | ISO 868    | 65                | Shore A             |
| Breaking stress            | ISO 37     | 3,5               | N/mm <sup>2</sup>   |
| Breaking elongations       | ISO 37     | 200               | %                   |
| Tear strength              | ISO 34-1   | 12                | N/mm <sup>2</sup>   |

Table 4 Silicon Rubber main features

At every existing interface, the adhesion strength (interface resistance) shall be higher than the tear strength of the silicone.

Silicone-rubber shall have a resistance to tracking and electric erosion with a classification of Class 1A 4,5 according to IEC 60587 and shall resist the effects of corona discharges and ozone. It shall withstand a low-current arc discharge for more than 300 seconds under the conditions indicated in standard IEC 61621 and its volume resistivity shall be over 10<sup>10</sup> Ω·m according to IEC 62631.

The silicone-rubber shall be type V0 according to IEC 60695-11-10.

Additionally, the silicone rubber shall have highly hydrophobic features and shall be classified type WC1 as specified in IEC TS 62073.

## 7.2 Fixation

Arresters shall be mounted on an insulating arm, which shall be included in the supply. This insulating material of the support shall accomplish the IEC 62217 weathering test.

The insulating arm shall resist the mechanical stress (surge-arrester weight and wind effect). The insulator shall be able to withstand over time atmospheric agents (rain, pollution and solar radiation, etc.). In case of intervention of the release device, the support insulator shall allow the operation of the network for a certain time, even if limited.

The support insulator shall have a minimum creepage distance of 200 mm, and have a minimum dry atmospheric impulse withstand voltage (wave 1.2 / 50 $\mu$ s) and wet industrial frequency, equal to 73 kV and 40 kV respectively.

In order to mount the insulating arm, it shall be provided of three holes as shown in figure 1.

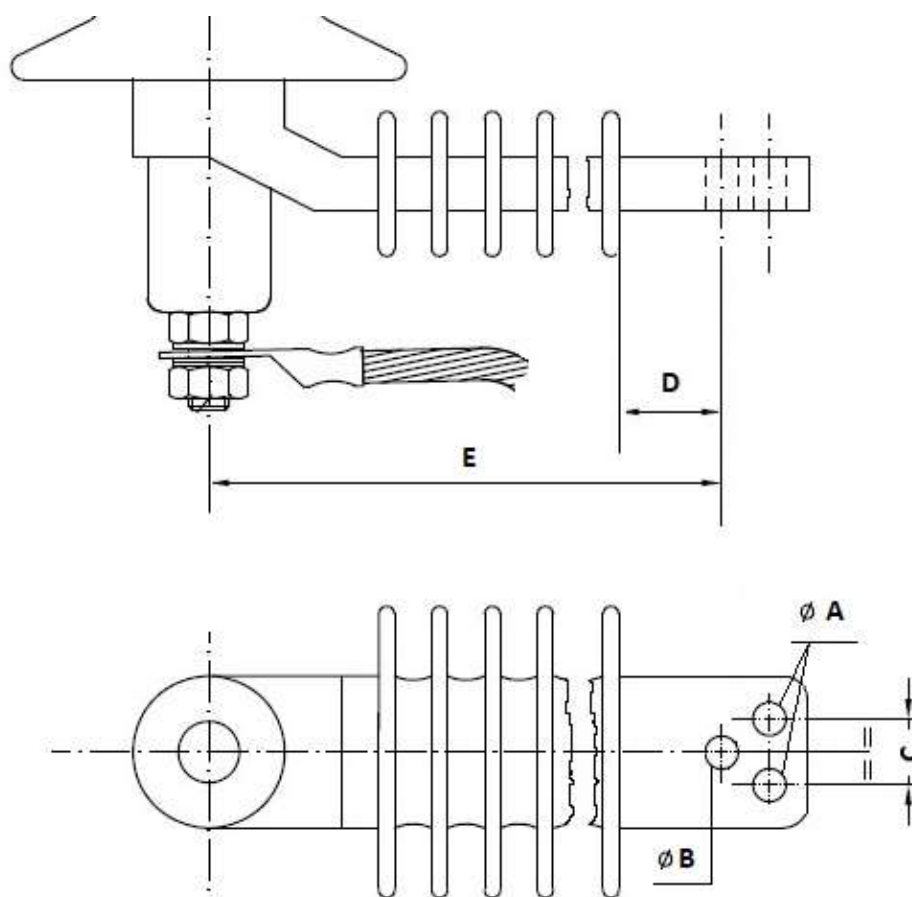



Figure 1 – Insulating Arm

| A    | B    | C    | D min | E max |
|------|------|------|-------|-------|
| [mm] | [mm] | [mm] | [mm]  | [mm]  |
| 13   | 13   | 25   | 100   | 200   |

|   |  |                               |
|---|--|-------------------------------|
|  | GLOBAL STANDARD  | Page 14 of 24                 |
|   | METAL-OXIDE POLYMER-HOUSED SURGE ARRESTERS WITHOUT GAPS FOR MV LINES | GSCC016<br>Rev. 02<br>12/2020 |

### 7.3 Terminals to conductor and to disconnecter

Connection terminal to conductor shall be made of stainless steel. It shall be M12.

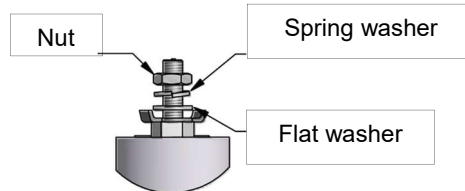

Figure 2 - Terminal

The terminal to the disconnecter shall also be M12.

### 7.4 Disconnecter

Surge arresters shall be equipped with a disconnection device that will act in case of failure in operation, avoiding a permanent fault and, at the same time, pointing out the defective item in a visible way (see Annex A for some exceptions).

The disconnecter shall be supplied mounted at the bottom of the surge-arrester.

The disconnecter shall be connected to a copper braid (minimum cross section, 25 mm<sup>2</sup> and length between 450 mm and 550 mm), the braid shall be equipped with a tinned copper terminal in the opposite extreme (13 mm). The copper braid could be supplied mounted or as an accessory, always with the required nuts and washers to be mounted on the terminal from the disconnecter and being necessary to know the torque for its adjustment.

For E-Distribución (Spain) the copper braid shall be supplied mounted and not as an accessory.

### 7.5 Protective treatments

Iron parts shall be in non-corrosive material or hot dip galvanized in compliance with ISO 1461 (or other international equivalent standards).

The different metallic materials will always be designed to avoid galvanic corrosion.

Nuts and bolts shall be in stainless steel.

### 7.6 Grounding

The manufacturer shall ensure the different forming parts of the equipment remain equipotential.

### 7.7 Other characteristics

The whole design shall make easy its installation and cleaning, avoiding water retention.

|   |  |                               |
|---|--|-------------------------------|
|  | GLOBAL STANDARD  | Page 15 of 24                 |
|   | METAL-OXIDE POLYMER-HOUSED SURGE ARRESTERS WITHOUT GAPS FOR MV LINES | GSCC016<br>Rev. 02<br>12/2020 |

## 8 MARKING

Metal oxide surge arresters shall be identified with a nameplate in stainless steel permanently attached to the arrester. Alternative materials can be considered if the manufacturer proves the marking endurance through time (this solution shall be approved by Enel distribution companies).

In accordance with IEC 60099-4, nameplates shall include:

- Manufacturer's name or trade mark, type and identification of the complete arrester
- Serial number
- The year of manufacture
- Enel Country code
- Designation of arrester (according to point 6: class, Continuous operating voltage,  $U_c$ , in kV and Rated voltage,  $U_r$ , in kV)
- Rated frequency
- Nominal discharge current,  $I_n$ , in kA
- Rated short-circuit current,  $I_s$ , in kA
- Contamination withstand level of the enclosure
- ENEL

## 9 TESTING

Tests shall be performed according to IEC 60099-4.

These tests are divided into three groups:

- Type tests (Design tests)
- Routine tests
- Acceptance tests

Type tests are performed once, during the TCA process. Routine and Acceptance tests shall be carried out on every singular purchased lot, as an acceptance tests.

### 9.1.1 Type Tests (Design Tests)

Type Tests must be according to IEC 60099-4, see the related clauses in the following table:

|   |  |                               |
|---|--|-------------------------------|
|  | GLOBAL STANDARD  | Page 16 of 24                 |
|   | METAL-OXIDE POLYMER-HOUSED SURGE ARRESTERS WITHOUT GAPS FOR MV LINES | GSCC016<br>Rev. 02<br>12/2020 |

| N°   | Type tests Surge Arresters  | Distribution Class        |
|------|---|---------------------------|
|      | Nominal discharge current   | 10 kA                     |
|      | Typical Us (kV), rms value  | ≤ 52                      |
|      |   | <i>Clause IEC 60099-4</i> |
| 1    | Insulation withstand tests on the arrester housing                                | 10.8.2 (equal to 8.2)     |
|      | a) Lightning impulse  | 8.2.6                     |
|      | b) Power-frequency  | 8.2.8                     |
| 2    | Residual voltage test   | 10.8.3 (equal to 8.3)     |
|      | a) Step current impulse   | 8.3.2                     |
|      | b) Lightning impulse  | 8.3.3                     |
| 3    | Test to verify long term stability under continuous operating voltage             | 10.8.4 (equal to 8.4)     |
| 4    | Repetitive charge transfer withstand  | 10.8.5 (equal to 8.5)     |
| 5    | Heat dissipation behaviour verification of test sample                            | 10.8.6 (equal to 8.6)     |
| 6    | Operating duty test   | 10.8.7                    |
| 7    | Power-frequency voltage versus time   | 18.8.8                    |
| 8    | Arrester disconnect/fault indicator   | 10.8.9 (equal to 8.9)     |
| 9    | Short-circuit tests   | 10.8.10                   |
| 10   | Bending moment  | 10.8.11                   |
| 11   | Test on insulating base and mounting bracket                                      | 8.11.6                    |
| 12 * | Radio interference voltage (RIV)  | 10.8.14 (equal to 8.14)   |
| 13*  | Test to verify the dielectric withstand of the internal components of an arrester | 10.8.15 (equal to 8.15)   |
| 14   | Test of internal grading components   | 10.8.16 (equal to 8.16)   |
| 15   | Weather ageing test   | 10.8.17                   |
|      | <i>Comments:</i>  |                           |
| 16*  | <i>Optional</i>   |                           |
|      | <b>Type tests Insulating Support</b>  |                           |
| 16   | Dry lightning impulse withstand voltage test                                      | IEC 60383-2               |
| 17   | Wet power frequency test  | IEC 60383-2               |
|      | <b>Type tests housing material</b>  |                           |
| 18   | Density   | ISO 1183-1                |
| 19   | Breaking stress   | ISO 37                    |
| 20   | Breaking elongation   | ISO 37                    |
| 21   | Tear strength   | ISO 34-1                  |
| 22   | Low current arc discharge   | IEC 61621                 |
| 23   | Hardness test   | ISO 868                   |
| 24   | Tracking and erosion test   | IEC 60587                 |
| 25   | Flammability test   | IEC 60695-11-10           |

Table 5 Type test list



|   |  |                               |
|---|--|-------------------------------|
|  | GLOBAL STANDARD  | Page 17 of 24                 |
|   | METAL-OXIDE POLYMER-HOUSED SURGE ARRESTERS WITHOUT GAPS FOR MV LINES | GSCC016<br>Rev. 02<br>12/2020 |

### 9.1.2 Routine tests

| N° | Routine tests   |
|----|---|
| 1  | Measurement of reference voltage ( $U_{ref}$ )        |
| 2  | Residual voltage test (for lightning current impulse) |
| 3  | Internal partial discharge test                       |
| 4  | Proper assembly of disconnector                       |

Table 6 Routine Test list

See IEC 60099-4, clause 9.1.

### 9.1.3 Acceptance tests

| N° | Acceptance tests  |
|----|---|
| 1  | Measurement of power frequency voltage at the reference current |
| 2  | Lightning impulse residual voltage at nominal discharge current |
| 3  | Internal partial discharge test                                 |

Table 7 Acceptance test list

See IEC 60099-4, clause 9.2.

### 9.1.4 Sample plan

In order to realize the acceptance for each purchased lot, it shall be necessary to accomplish:

- Visual inspection
- Routine tests
- Acceptance tests

These tests shall be made on the nearest lower whole number to the cube root of the number of arresters from the lot, upon detecting a single non-conforming piece this will lead to the rejection of the whole batch.

|   |  |                               |
|---|--|-------------------------------|
|  | GLOBAL STANDARD  | Page 18 of 24                 |
|   | METAL-OXIDE POLYMER-HOUSED SURGE ARRESTERS WITHOUT GAPS FOR MV LINES | GSCC016<br>Rev. 02<br>12/2020 |

## 10 TECHNICAL CONFORMITY ASSESSMENT

Technical Conformity is issued by Enel Group according to the Global Standard GSCG002 and shall be supported by accomplishing all of the Type and Sample tests on every type of surge-arrester to be accredited. Type tests are performed once and shall be repeated when it changes the design of the equipment, the materials, production process or the reference standards (if these changes could affect them).

### 10.1 Local Certifications

For Colombia, RETIE certification shall be also provided according to local regulation (see 2.1).

## 11 GUARANTEE

Requirement of warranty will be indicated in the request for bids, indicating periods and standards, although any material will be warrantied 24 months as a minimum.

## 12 CONDITIONS OF SUPPLY

All the packages shall be properly identified about transport and destination.

Manufacturers shall provide appropriate instructions, documents showing routine tests and information covering general conditions during transport, storage and installation of the materials. These instructions must include recommendations for handling, cleaning or maintenance. The documents must be in the local language of the destiny country.

The material will be supplied packed in wood crates or hard cardboard boxes. Boxes can be individuals or include more than one surge arrester, but they shall be securely packaged to prevent them to touch each other and to avoid any damage to sheds during storing, loading and transportation.

The consistency of the boxes shall permit a three-ply storage/transportation and they shall be prepared for handling by forklift trucks and by boom cranes. They also must be treated to prevent degradation over time.

Package dimension shall be in compliance with palettes 80x120 cm (ISO 3676).

All wood used in the packaging shall be conveniently treated in accordance with the phytosanitary regulations of the destination country.

|  |  |                               |
|--|--|-------------------------------|
|  | GLOBAL STANDARD  | Page 19 of 24                 |
|  | METAL-OXIDE POLYMER-HOUSED SURGE ARRESTERS WITHOUT GAPS FOR MV LINES | GSCC016<br>Rev. 02<br>12/2020 |

### 13 ANNEX A TECHNICAL REQUIREMENTS

| Country   | GS code    | Country code | Designation              | Rated frequency [Hz] | Rated voltage Ur [kV] | Continuous operating voltage (Max) UC [kV] | Nominal discharge current In [kA] | Min Repetitive charge transfer rating Qrs [C] | Min Thermal charge transfer rating Qth [C] | Rated short-circuit current IS [kA] | Max Residual voltage for lightning impulse [kV] | BIL [kV] | C.L 60815 | Creepage distance [mm] | Surge arrester Max total length [mm] | Max Surge arrester diameter [mm] | Bending moment [Nm] |
|-----------|------------|--------------|--------------------------|----------------------|-----------------------|--|-----------------------------------|---|--|-------------------------------------|---|----------|-----------|------------------------|--------------------------------------|----------------------------------|---------------------|
| Brazil    | GSCC016/01 | 312123       | SA MOV DH UR-3,3/UC-2,55 | 60                   | 3,3                   | 2,55                                       | 10                                | 0,4   | 1,1  | 20                                  | 12  | 40       | E         | 200                    | 500                                  | 140                              | 30                  |
| Romania   | GSCC016/02 | 617302       | SA MOV DH UR-7,2/UC-6    | 50                   | 7,2                   | 6  | 10                                | 0,4   | 1,1  | 20                                  | 37  | 60       | E         | 322                    | 500                                  | 140                              | 30                  |
| Colombia  | GSCC016/03 | 6781248      | SA MOV DH UR-12/UC-10,2  | 50-60                | 12                    | 10,2                                       | 10                                | 0,4   | 1,1  | 20                                  | 36  | 95       | E         | 560                    | 500                                  | 140                              | 30                  |
| Brazil    | GSCC016/03 | T170497      | SA MOV DH UR-12/UC-10,2  | 50-60                | 12                    | 10,2                                       | 10                                | 0,4   | 1,1  | 20                                  | 36  | 95       | E         | 560                    | 500                                  | 140                              | 30                  |
| Spain     | GSCC016/03 | 170073       | SA MOV DH UR-12/UC-10,2  | 50-60                | 12                    | 10,2                                       | 10                                | 0,4   | 1,1  | 20                                  | 36  | 95       | E         | 560                    | 500                                  | 140                              | 30                  |
| Perú      | GSCC016/03 | 860170       | SA MOV DH UR-12/UC-10,2  | 50-60                | 12                    | 10,2                                       | 10                                | 0,4   | 1,1  | 20                                  | 36  | 95       | E         | 560                    | 500                                  | 140                              | 30                  |
| Italy     | GSCC016/03 | 170011       | SA MOV DH UR-12/UC-10,2  | 50-60                | 12                    | 10,2                                       | 10                                | 0,4   | 1,1  | 20                                  | 36  | 95       | E         | 560                    | 500                                  | 140                              | 30                  |
| Romania   | GSCC016/03 | 170011       | SA MOV DH UR-12/UC-10,2  | 50-60                | 12                    | 10,2                                       | 10                                | 0,4   | 1,1  | 20                                  | 36  | 95       | E         | 560                    | 500                                  | 140                              | 30                  |
| Chile     | GSCC016/04 | 170377       | SA MOV DH UR-15/UC-12,7  | 50-60                | 15                    | 12,7                                       | 10                                | 0,4   | 1,1  | 20                                  | 54  | 95       | E         | 528                    | 500                                  | 140                              | 30                  |
| Argentina | GSCC016/04 | 0108-0633    | SA MOV DH UR-15/UC-12,7  | 50-60                | 15                    | 12,7                                       | 10                                | 0,4   | 1,1  | 20                                  | 54  | 95       | E         | 528                    | 500                                  | 140                              | 30                  |
| Italy     | GSCC016/05 | 170012       | SA MOV DH UR-18/UC-15,3  | 50-60                | 18                    | 15,3                                       | 10                                | 0,4   | 1,1  | 20                                  | 54  | 125      | E         | 805                    | 500                                  | 140                              | 30                  |
| Perú      | GSCC016/05 | 860172       | SA MOV DH UR-18/UC-15,3  | 50-60                | 18                    | 15,3                                       | 10                                | 0,4   | 1,1  | 20                                  | 54  | 125      | E         | 805                    | 500                                  | 140                              | 30                  |
| Spain     | GSCC016/05 | 170039       | SA MOV DH UR-18/UC-15,3  | 50-60                | 18                    | 15,3                                       | 10                                | 0,4   | 1,1  | 20                                  | 54  | 125      | E         | 805                    | 500                                  | 140                              | 30                  |
| Spain     | GSCC016/06 | 170075       | SA MOV DH UR-21/UC-17    | 50-60                | 21                    | 17   | 10                                | 0,4   | 1,1  | 20                                  | 60  | 125      | D         | 661                    | 500                                  | 140                              | 30                  |
| Brazil    | GSCC016/06 | 312129       | SA MOV DH UR-21/UC-17    | 50-60                | 21                    | 17   | 10                                | 0,4   | 1,1  | 20                                  | 60  | 125      | D         | 661                    | 500                                  | 140                              | 30                  |
| Italy     | GSCC016/07 | 170013       | SA MOV DH UR-24/UC-20    | 50-60                | 24                    | 20   | 10                                | 0,4   | 1,1  | 20                                  | 65  | 125      | E         | 1075                   | 500                                  | 140                              | 30                  |
| Romania   | GSCC016/07 | 170013       | SA MOV DH UR-24/UC-20    | 50-60                | 24                    | 20   | 10                                | 0,4   | 1,1  | 20                                  | 65  | 125      | E         | 1075                   | 500                                  | 140                              | 30                  |
| Perú      | GSCC016/07 | 860171       | SA MOV DH UR-24/UC-20    | 50-60                | 24                    | 20   | 10                                | 0,4   | 1,1  | 20                                  | 65  | 125      | E         | 1075                   | 500                                  | 140                              | 30                  |
| Spain     | GSCC016/07 | 170076       | SA MOV DH UR-24/UC-20    | 50-60                | 24                    | 20   | 10                                | 0,4   | 1,1  | 20                                  | 65  | 125      | E         | 1075                   | 500                                  | 140                              | 30                  |
| Spain     | GSCC016/08 | 170078       | SA MOV DH UR-24/UC-20    | 50                   | 24                    | 20   | 10                                | 0,4   | 1,1  | 20                                  | 70  | 125      | E         | 1320                   | 500                                  | 140                              | 30                  |
| Chile     | GSCC016/9  | 170471       | SA MOV DH UR-27/UC-22    | 50                   | 27                    | 22   | 10                                | 0,4   | 1,1  | 20                                  | 97,2  | 145      | C         | 560                    | 570                                  | 140                              | 30                  |
| Argentina | GSCC016/10 | 0108-0249    | SA MOV DH UR-30/UC-24,4  | 50-60                | 30                    | 24,4                                       | 10                                | 0,4   | 1,1  | 20                                  | 108   | 170      | E         | 1075                   | 570                                  | 140                              | 30                  |
| Colombia  | GSCC016/10 | 6781249      | SA MOV DH UR-30/UC-24,4  | 50-60                | 30                    | 24,4                                       | 10                                | 0,4   | 1,1  | 20                                  | 108   | 170      | E         | 1075                   | 570                                  | 140                              | 30                  |
| Spain     | GSCC016/10 | 170191       | SA MOV DH UR-30/UC-24,4  | 50-60                | 30                    | 24,4                                       | 10                                | 0,4   | 1,1  | 20                                  | 108   | 170      | E         | 1075                   | 570                                  | 140                              | 30                  |
| Brazil    | GSCC016/10 | T170149      | SA MOV DH UR-30/UC-24,4  | 50-60                | 30                    | 24,4                                       | 10                                | 0,4   | 1,1  | 20                                  | 108   | 170      | E         | 1075                   | 570                                  | 140                              | 30                  |
| Spain     | GSCC016/11 | 170077       | SA MOV DH UR-36/UC-29    | 50                   | 36                    | 29   | 10                                | 0,4   | 1,1  | 20                                  | 96  | 170      | E         | 1120                   | 570                                  | 140                              | 30                  |

|   |   |                               |
|---|---|-------------------------------|
|  | GLOBAL STANDARD   | Page 20 of 24                 |
|   | METAL-OXIDE POLYMER-HOUSED SURGE<br>ARRESTERS WITHOUT GAPS FOR MV LINES | GSCC016<br>Rev. 02<br>12/2020 |

## 14 ANNEX B- LOCAL SECTIONS

### 14.1 E-DISTRIBUZIONE-ITALIA, E-DISTRIBUȚIE BANAT, E-DISTRIBUȚIE DOBROGEA, E-DISTRIBUȚIE MUNTENIA

#### 14.1.1 Replaced Local standards:

- DY 557
- DY 1017
- DY 1018

#### 14.2 Supply

Package dimension shall be in compliance with the standard GUI 101 - CARATTERISTICHE GENERALI E PRESCRIZIONI DI IMPIEGO DEL PALLET IN LEGNO DA UTILIZZARE PER L'IMBALLO DI TRASPORTO

### 14.3 ENDESA DISTRIBUCIÓN ELÉCTRICA- SPAIN

#### 14.3.1 Replaced Local standards:

- AND015
- Technical specifications number 6700522, 6702801, 6703001, 6703002, 6703004, 6703005, 6703007, 6779962

### 14.4 ENEL DISTRIBUCION COLOMBIA

#### 14.4.1 Replaced Local standards:

- E-MT-031

#### 14.4.2 Reference local law and standards:

- NSR10 Reglamento Colombiano de Construcción Sismo Resistente

### 14.5 ENEL DISTRIBUCION PERÚ

#### 14.5.1 Replaced Local standards:

- E-MT-031

### 14.6 ENEL DISTRIBUCION CHILE

#### 14.6.1 Replaced Local standards:

- E-MT-031

#### 14.6.2 Reference local law and standards:

- ETGI-1020 - Especificaciones técnicas generales - Requisitos de diseño sísmico para equipo eléctrico. Ingendesa, Noviembre 1997.

|   |   |                               |
|---|---|-------------------------------|
|  | GLOBAL STANDARD   | Page 21 of 24                 |
|   | METAL-OXIDE POLYMER-HOUSED SURGE<br>ARRESTERS WITHOUT GAPS FOR MV LINES | GSCC016<br>Rev. 02<br>12/2020 |

**14.7 ENEL DISTRIBUCAO RIO, ENEL DISTRIBUCAO CEARÁ, ENEL DISTRIBUCAO GOIAS, ENEL SAO PAULO**

**14.7.1 Replaced Local standards:**

- E-MT-031

|   |  |                               |
|---|--|-------------------------------|
|  | GLOBAL STANDARD  | Page 22 of 24                 |
|   | METAL-OXIDE POLYMER-HOUSED SURGE ARRESTERS WITHOUT GAPS FOR MV LINES | GSCC016<br>Rev. 02<br>12/2020 |

## 15 ANNEX C - TECHNICAL CHECK LIST

| Item     | Description   |                 |                            |                |
|----------|---|-----------------|----------------------------|----------------|
| <b>1</b> | <b>GENERAL INFORMATION</b>  |                 |                            |                |
| 1.1      | Supplier  |                 |                            |                |
| 1.2      | Factory   |                 |                            |                |
| 1.3      | Distribution Company or Country                                     |                 |                            |                |
| 1.4      | Country Code  |                 |                            |                |
| 1.5      | GS Type Code  |                 |                            |                |
| 1.6      | Designation   |                 |                            |                |
| 1.7      | Supplier reference  |                 |                            |                |
| <b>2</b> | <b>TECHNICAL CHARACTERISTICS</b>                                    | <b>Unit</b>     | <b>Required</b>            | <b>Offered</b> |
| 2.1      | Rated Voltage ( $U_r$ )   | kV              |                            |                |
| 2.2      | Continuous Operating Voltage ( $U_c$ )                              | kV              |                            |                |
| 2.3      | Rated Frequency   | Hz              |                            |                |
| 2.4      | Nominal discharge current, lightning impulse 8/20 $\mu$ s ( $I_n$ ) | kA              | 10                         |                |
| 2.5      | Class (DH/DM/DL)  |                 | DH                         |                |
| 2.6      | Insulation withstand test   |                 | Ac. IEC 60099_4            |                |
| 2.7      | Current for Short-circuit test                                      | kA              | 16                         |                |
| 2.8      | Residual Voltage for Step current impulse (max)                     | kV              | informative                |                |
| 2.9      | Residual Voltage for Lightning impulse (max)                        | kV              |                            |                |
| 2.10     | Residual Voltage for Switching impulse (max)                        | kV              | informative                |                |
| 2.11     | Repetitive Charge transfer ( $Q_{rs}$ ) (min)                       | C               | 0,4                        |                |
| 2.12     | Thermal Charge transfer rating ( $Q_{th}$ ) (min)                   | C               | 1,1                        |                |
| 2.13     | Creepage distance   | mm              |                            |                |
| 2.14     | Bending moment  | N·m             | Ac. IEC 60099_4            |                |
| 2.15     | Galvanization   | $\mu$ m         | Ac. ISO 1461 or equivalent |                |
| 2.16     | Disconnecter  |                 | Yes                        |                |
| 2.17     | Terminal to conductor   |                 | Stainless Steel, M12       |                |
| 2.18     | Terminal to disconnector  |                 | Stainless Steel, M12       |                |
| 2.19     | Minimun braid disconnector length                                   | mm              | 450                        |                |
| 2.20     | Minimun braid disconnector section                                  | mm <sup>2</sup> | 25                         |                |
| 2.21     | End braid terminal  |                 | Yes                        |                |
| 2.22     | Max length  | mm              |                            |                |
| 2.23     | Housing max diameter  | mm              |                            |                |
| 2.24     | Insulator arm max length  | mm              | 200                        |                |
| 2.25     | Insulator arm holes diameter  | mm              | 12                         |                |
| 2.26     | Insulator arm holes center's distance                               | mm              | 25                         |                |

|   |  |                               |
|---|--|-------------------------------|
|  | GLOBAL STANDARD  | Page 23 of 24                 |
|   | METAL-OXIDE POLYMER-HOUSED SURGE ARRESTERS WITHOUT GAPS FOR MV LINES | GSCC016<br>Rev. 02<br>12/2020 |

## 16 ANNEX D - STANDARDIZED DESIGNATION TO CREATE NEW CODES

In order to create new codes for insulators included in this standard, the designation for the distribution surge arresters according to this Global Standard shall be:

- SA MOV (SURGE ARRESTER METAL OXIDE VARISTOR)
- DH (DISTRIBUTION HIGH CLASS)
- Nominal discharge current in kA (10 for DH class)
- UR - Rated Voltage in kV
- UC - Continuous operating voltage in kV
- Ures – Maximum residual voltage in kV

Example for code 170078: SA MOV DH10-UR 24-UC 20-Ures 70

### 17 ANNEX E, APPLICABILITY TEST TABLE

| Technical specification reference | IEC                                 | Test Description                    | Test applicability        | Test Report reference   |  |      | Applicability report   |      |      |      |
|-----------------------------------|-------------------------------------|-------------------------------------|---------------------------|---|--|------|--|------|------|------|
|                                   |                                     |                                     |                           | Name  | Laboratory                                   | Date | Name and revision of technical specification and/or standard referenced in the test report | Name | Rev. | Date |
| GSCC016 9.1.1                     | IEC 60099-4 10.8.2 (equal to 8.2)   | <i>Surge arrester</i>               |                           |   |  |      |  |      |      |      |
| GSCC016 9.1.1                     | IEC 60099-4 8.2.6                   |                                     |                           | a) Lightning impulse  |  |      |  |      |      |      |
| GSCC016 9.1.1                     | IEC 60099-4 8.2.8                   |                                     |                           | b) Power-frequency  |  |      |  |      |      |      |
| GSCC016 9.1.1                     | IEC 60099-4 10.8.3 (equal to 8.3)   |                                     |                           | Residual voltage test   |  |      |  |      |      |      |
| GSCC016 9.1.1                     | IEC 60099-4 8.3.2                   |                                     |                           |   | a) Step current impulse                      |      |  |      |      |      |
| GSCC016 9.1.1                     | IEC 60099-4 8.3.3                   |                                     |                           | b) Lightning impulse  |  |      |  |      |      |      |
| GSCC016 9.1.1                     | IEC 60099-4 10.8.4 (equal to 8.4)   |                                     |                           | Test to verify long term stability under continuous operating voltage             |  |      |  |      |      |      |
| GSCC016 9.1.1                     | IEC 60099-4 10.8.5 (equal to 8.5)   |                                     |                           | Repetitive charge transfer withstand  |  |      |  |      |      |      |
| GSCC016 9.1.1                     | IEC 60099-4 10.8.6 (equal to 8.6)   |                                     |                           | Heat dissipation behaviour verification of test sample                            |  |      |  |      |      |      |
| GSCC016 9.1.1                     | IEC 60099-4 10.8.7                  |                                     |                           | Operating duty test   |  |      |  |      |      |      |
| GSCC016 9.1.1                     | IEC 60099-4 18.8.8                  |                                     |                           | Power-frequency voltage versus time   |  |      |  |      |      |      |
| GSCC016 9.1.1                     | IEC 60099-4 10.8.9 (equal to 8.9)   |                                     |                           | Arrester disconnect/fault indicator   |  |      |  |      |      |      |
| GSCC016 9.1.1                     | IEC 60099-4 10.8.10                 |                                     |                           | Short-circuit tests   |  |      |  |      |      |      |
| GSCC016 9.1.1                     | IEC 60099-4 10.8.11                 |                                     |                           | Bending moment  |  |      |  |      |      |      |
| GSCC016 9.1.1                     | IEC 60099-4 8.11.6                  |                                     |                           | Test on insulating base and mounting bracket                                      |  |      |  |      |      |      |
| GSCC016 9.1.1                     | IEC 60099-4 10.8.14 (equal to 8.14) |                                     |                           | Radio interference voltage (RIV)  |  |      |  |      |      |      |
| GSCC016 9.1.1                     | IEC 60099-4 10.8.15 (equal to 8.15) |                                     |                           | Test to verify the dielectric withstand of the internal components of an arrester |  |      |  |      |      |      |
| GSCC016 9.1.1                     | IEC 60099-4 10.8.16 (equal to 8.16) |                                     |                           | Test of internal grading components   |  |      |  |      |      |      |
| GSCC016 9.1.1                     | IEC 60099-4 10.8.17                 |                                     |                           | Weather ageing test   |  |      |  |      |      |      |
| GSCC016 9.1.1                     | IEC 60383-2                         |                                     |                           | Bracket Electrical characteristics  | Dry lightning impulse withstand voltage test |      |  |      |      |      |
| GSCC016 9.1.1                     | IEC 60383-2                         | Wet power frequency test            |                           |   |  |      |  |      |      |      |
| GSCC016 9.1.1                     | ISO 1183-1                          | <i>Tests on SA housing material</i> | Density                   |   |  |      |  |      |      |      |
| GSCC016 9.1.1                     | ISO 37                              |                                     | Breaking stress           |   |  |      |  |      |      |      |
| GSCC016 9.1.1                     | ISO 37                              |                                     | Breaking elongation       |   |  |      |  |      |      |      |
| GSCC016 9.1.1                     | ISO 34-1                            |                                     | Tear strength             |   |  |      |  |      |      |      |
| GSCC016 9.1.1                     | IEC 61621                           |                                     | Low current arc discharge |   |  |      |  |      |      |      |
| GSCC016 9.1.1                     | ISO 868                             |                                     | Hardness test             |   |  |      |  |      |      |      |
| GSCC016 9.1.1                     | IEC 60587                           |                                     | Tracking and erosion test |   |  |      |  |      |      |      |
| GSCC016 9.1.1                     | IEC 60695-11-10                     |                                     | Flammability test         |   |  |      |  |      |      |      |